

LED Wall Sconce

WS14935
INSTALLATION SHEET

START FROM HERE

- Make sure power is completely off at the fuse box.
- Have your fixture installed by a qualified licensed electrician
- Prepare everything in a clear area.
- Wear gloves at all times during this installation.
- Read instructions carefully before you start assembly.
- Keep this instruction sheet for future reference.

Technical Support: 1-855-855-8926

Please Note:

- For dimming, a TRIAC or an ELV type of dimmer is required.

- 1.** Remove the fixture from its original packaging. Remove the mounting plate (**1c**) from the canopy (**2a**) by removing the two screws (**2b**). Attach the mounting plate (**1c**) to the electrical junction box (**1a**) using the two screws (**1d**) provided in the hardware package.
- 2.** Connect all wiring with the provided marrettes (**1b**) (white to white "N", black to black "L", ground to ground "G"). Attach the canopy (**2a**) to the mounting plate (**1c**) and secure with two screws (**2b**).
- 3.** You have now completed the installation of your fixture, enjoy.

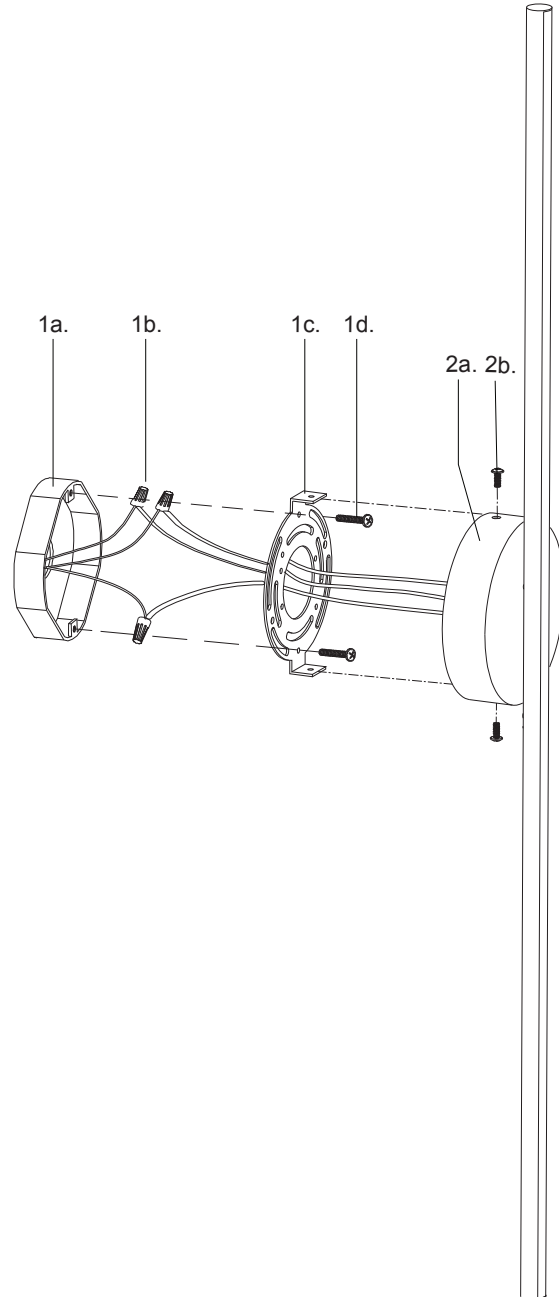

KUZCO

19054 28th Avenue Surrey, BC Canada V3Z 6M3
T: 604 538 7162 TF: 1-855 85 KUZCO F: 604 538 7196
W: kuzcolighting.com
20190102