

ASSEMBLY AND INSTALLATION INSTRUCTIONS

T0219

WARNING: TO AVOID RISK OF ELECTRICAL SHOCK, BE SURE TO SHUT OFF POWER BEFORE INSTALLING OR SERVICING THIS FIXTURE.

NOTES: 1. Before installing, consult local electrical codes for wiring and grounding requirements.
2. READ AND SAVE THESE INSTRUCTIONS.

Hardware Package (included):

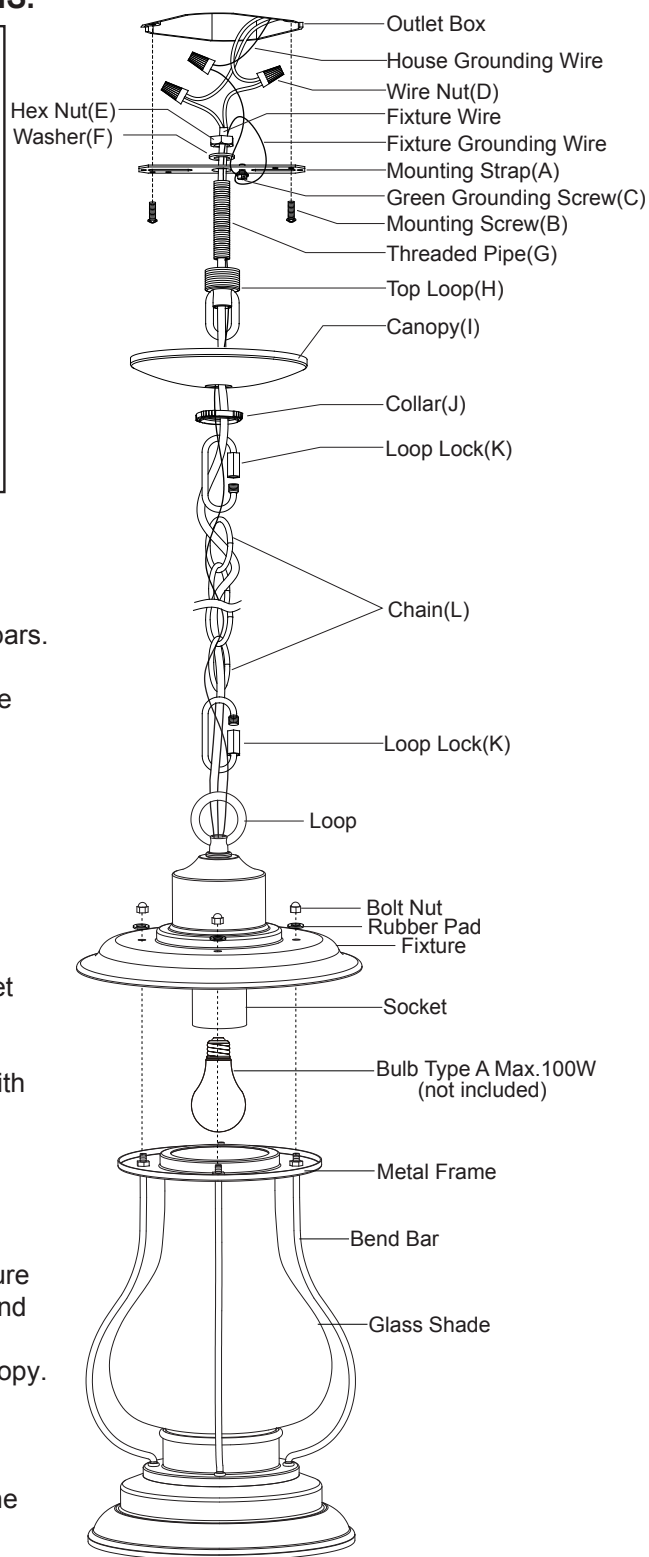
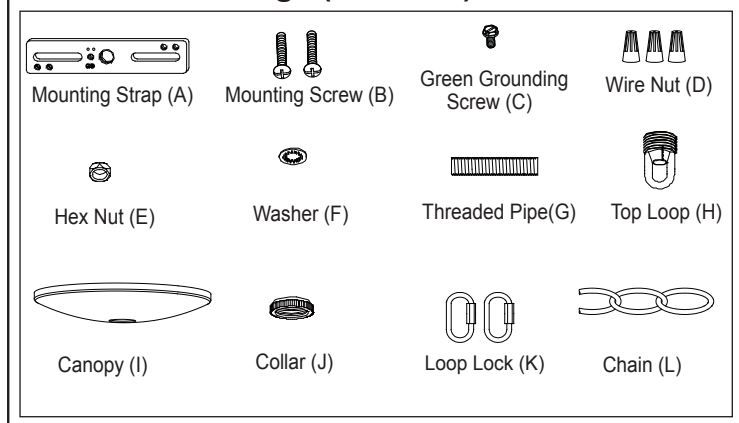

Installation Steps

Turn off the power at fuse or circuit box

1. Remove the EVA plugged between glass shade and bend bars.
2. Attach threaded pipe to the mounting strap, and then secure it with a washer and a hex nut.
3. Attach mounting strap to the outlet box using two mounting screws.
4. Unscrew four bolt nuts and four rubber pads to remove the metal frame from the fixture.
5. Install a bulb (not included). Check relamping label at socket area or packaging for maximum allowed wattage.
6. Attach the metal frame back to fixture, and then secure it with four rubber pads and four bolt nuts.
7. Secure the top loop to the threaded pipe.
8. Connect the chain:
 - Determine needed length of chain to achieve desired fixture height. (To remove excess chain section, use pliers to bend link open.)
 - Weave the fixture wires through the chain, collar and canopy.
9. Connect one end of the chain to the loop using a loop lock.
10. Connect the other end of the chain to the top loop using the other loop lock.
11. Thread the fixture wire and fixture grounding wire through the top loop, threaded pipe and mounting strap.











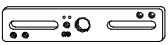

12. Pull out the source wires from the outlet box. Make wire connections using wire nuts as follows:
 - Connect the smooth-coated wire (marked) from the fixture to the black wire from the power source.
 - Connect the ribbed-coated wire (unmarked) from the fixture to the white wire from the power source.
 - Attach the fixture grounding wire to the mounting strap with the green grounding screw, and then connect it to the house grounding wire with a wire nut.
 Carefully put the wires back into the outlet box.

13. Attach the canopy to the mounting strap, insert the top loop through hole, and then secure it by tightening collar.

Turn on the power at fuse or circuit box

The following parts are available for re-order if damaged or missing.

Spare Parts List:

 Mounting Strap (A)	 Mounting Screw (B)	 Green Grounding Screw (C)	 Wire Nut (D)
 Hex Nut (E)	 Washer (F)	 Threaded Pipe (G)	 Top Loop (H)
 Canopy (I)	 Collar (J)	 Loop Lock (K)	 Chain (L)

 Bottom Bolt Nut
 5505BB(4PCS)

← Assembly Kit
5496MM (1 SET)

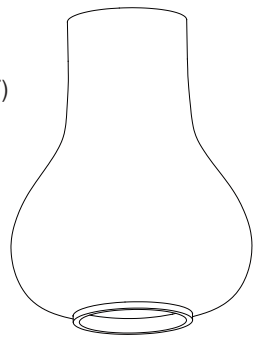
 Glass Shade
 9801C (1PC)

